

Varenummer: 4320000551  
Beskrivelse: Rota-fix spændelement A 55x85  
Rustfast stål

## Mål

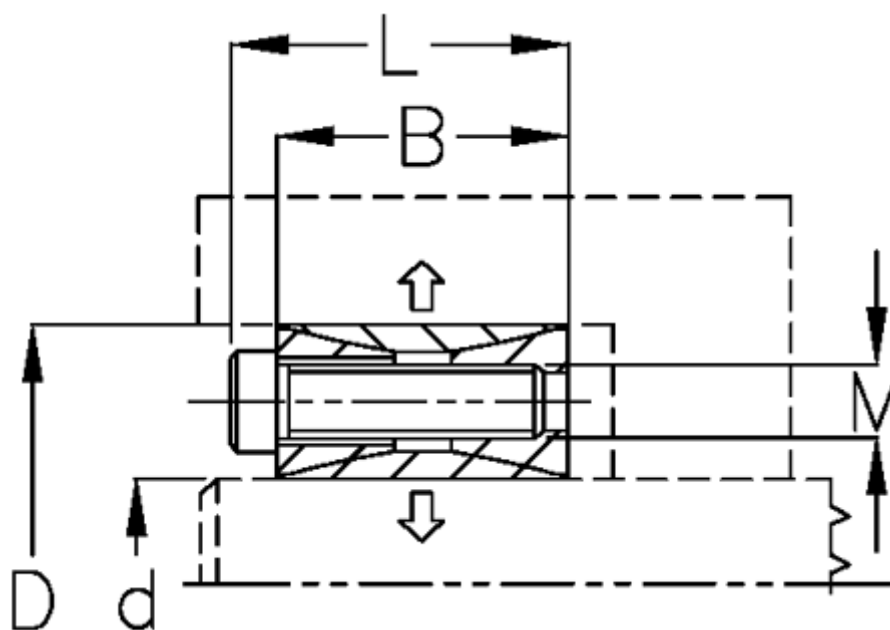

B mm	= 24
d H8 mm	= 55
D mm	= 85
F kN aksialkraft	= 51.6
L mm	= 32
M mm	= M8
Overfladeruhed	= R? ? 3.2 $\mu$ m
P N/mm <sup>2</sup> fladetryk på aksel/nav	= 48

T Nm drejningsmoment	= 1400
Tolerance	= Aksel k11-h11, Nav M8
Ts Nm boltetilspændingsmoment	= 21.4